



EPAP ON PETRINEX A Year in Review

Shelley Weyman, *Manager – PAT*

Wendy French, *Technical Lead – PAT*

November 9, 2015

AGENDA

- 》 Introductions
- 》 EPAP on Petrinex
- 》 Declaration
 - Report
 - Theme applicability
- 》 Observations
- 》 Using the system
- 》 Assistance
- 》 Questions

EPAP ON
PETRINEX

- 》 EPAP on Petrinex in operation for over 12 months
- 》 System enhancements
 - Operator consultation
 - Petrinex/Fujitsu
- 》 System usage

**EPAP ON
PETRINEX**

EPAP on Petrinex (2014-10 to 2015-09)

Declaration submissions	340
AER workflows	819
Industry Review (IR) workflows	908
Compliance Assessment Indicator (CAI) hits	685,670

DECLARATION
REPORTS

- › Must be signed by **ALL** signing executives identified in 1st paragraph on signatory page
- › All versions of report are required to be signed (original OR revision)

DECLARATION
REPORTS

» Acceptable

**Declaration
Regarding AER Measurement and Reporting Requirements**

We, Fred Astair, Dancer and Aretha Franklin, songstress on behalf of
(the "Operator"), declare the following:

1. This Declaration covers the 12 calendar months ending July 2014.

The last date of submission of this Declaration is the last day of **September 2014**.

Fred Astair, Dancer

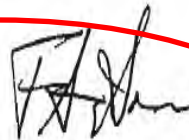

Date signed: *Sept 28, 2014*

Aretha Franklin, songstress

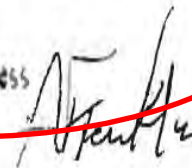

Date signed: *Sept 27, 2014*

Printed: 2015-09-18

》 Unacceptable – One signature

DECLARATION REPORTS

Declaration
Regarding AER Measurement and Reporting Requirements

We, Fred Astair, Dancer and Aretha Franklin, songstress on behalf of
(the "Operator"), declare the following:

1. This Declaration covers the 12 calendar months ending July 2014.

The last date of submission of this Declaration is the last day of **September 2014**.

Fred Astair, Dancer Date signed:

Aretha Franklin, songstress  Date signed: Sept 27, 2014

Printed: 2015-09-18

DECLARATION
REPORTS

» Unacceptable – One name

Declaration
Regarding AER Measurement and Reporting Requirements

We Fred Astair, Dancer and Aretha Franklin, songstress on behalf of
(the "Operator"), declare the following:

1. This Declaration covers the 12 calendar months ending July 2014.

The last date of submission of this Declaration is the last day of **September 2014**.

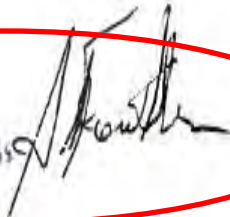
Aretha Franklin, songstress 

Date signed: Sept 27, 2014

Printed 2015-09-18

» Unacceptable – Signing on someone's behalf

DECLARATION REPORTS

Declaration
Regarding AER Measurement and Reporting Requirements

We, Fred Astair, Dancer and Aretha Franklin, songstress on behalf of
(the "Operator"), declare the following:

1. This Declaration covers the 12 calendar months ending July 2014.

The last date of submission of this Declaration is the last day of **September 2014**.

Fred Astair, Dancer 

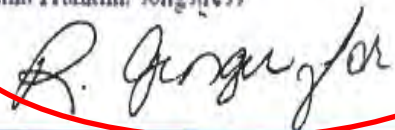
Aretha Franklin, songstress 

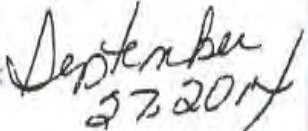
Date signed: 

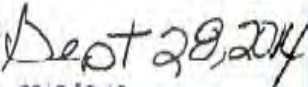
Date signed: 

Printed: 2015-09-18

DECLARATION
REPORTS

- 》 Must include **ALL** attachments (A, B, and C)
- 》 Declaration will be **REJECTED** for incomplete report

» FACILITY ASSESSMENT

- *The process of determining a facility's applicability to a declaration theme*

» EVALUATION OF CONTROLS

- *The process of determining whether an existing control is appropriately designed and being performed as intended*

**THEME
APPLICABILITY****》 SUB-TYPE EXCEPTIONS**

- 》 Themes #1 through 10 and #13
- Facilities within specific sub-types applicable to theme unless NOT receiving from or delivering to an upstream facility.

THEME APPLICABILITY

» Sub-type Exceptions

– Theme Information

Theme Name

1. Measurement System Design and Installation

Theme Description

Measurement system design and installation of any facility reporting to Petrinex

Control Objective

Ensure that measurement systems are designed and installed in accordance with AER requirements

Regulatory Reference

D017: 1, 2, 4, 6, 7, 8, 9, 10, 11, 12, 13, 14

Facility subtypes applicable to this theme

207, 208

311, 321, 322, 331, 341, 342, 343, 344, 345, 351, 361, 362, 363, 364, 365, 366, 367, 381

401, 402, 403, 404, 405, 406, 407

501, 502, 503, 504, 505, 506, 507, 508, 509

611, 612, 621, 622, 631, 632, 671, 673, 675

701

902, 903

Subtype Exceptions

406, 407, 671, 673, 675 - Unless facility is not receiving from or delivering to an upstream facility.

» **SUB-TYPE EXCEPTIONS**

» Theme #4 and theme #13

- Enhanced recovery schemes are not applicable to themes IF only injecting water.

THEME APPLICABILITY

» Sub-type Exceptions

■ Theme Information

Theme Name

4. Sampling & Analysis

Theme Description

Sampling and analysis of gas, hydrocarbon fluids and water

Control Objective

Ensure that representative samples are collected and analyzed using appropriate equipment and procedures

Regulatory Reference

D017: 8, 9, 11, 14 Appendix 4, 5, 7

Facility subtypes applicable to this theme

207, 208

311, 321, 322, 331, 341, 342, 343, 344, 345, 351, 361, 362, 363, 364, 365, 366, 367, 381

401, 402, 403, 404, 405, 406, 407

501, 502, 504, 505, 506, 508

611, 612, 621, 622, 631, 632, 671, 673, 675

701

902, 903

Subtype Exceptions

501, 508 - If the EOR approval is a water flood (refer to Table 8.3. on page 160 of Directive 017).

**THEME
APPLICABILITY**

- » **THEME #2—Measurement device maintenance (calibration, inspection, and proving)**
- » **THEME #3—Measurement device operation**

**THEME
APPLICABILITY****» GAS GATHERING SYSTEMS**

- Section 4.2.2.5 of *AER Directive 017* states in part, “Inlet measurement usually consists of the battery or facility group measurement point.”

MEASUREMENT DEVICE

THEME APPLICABILITY

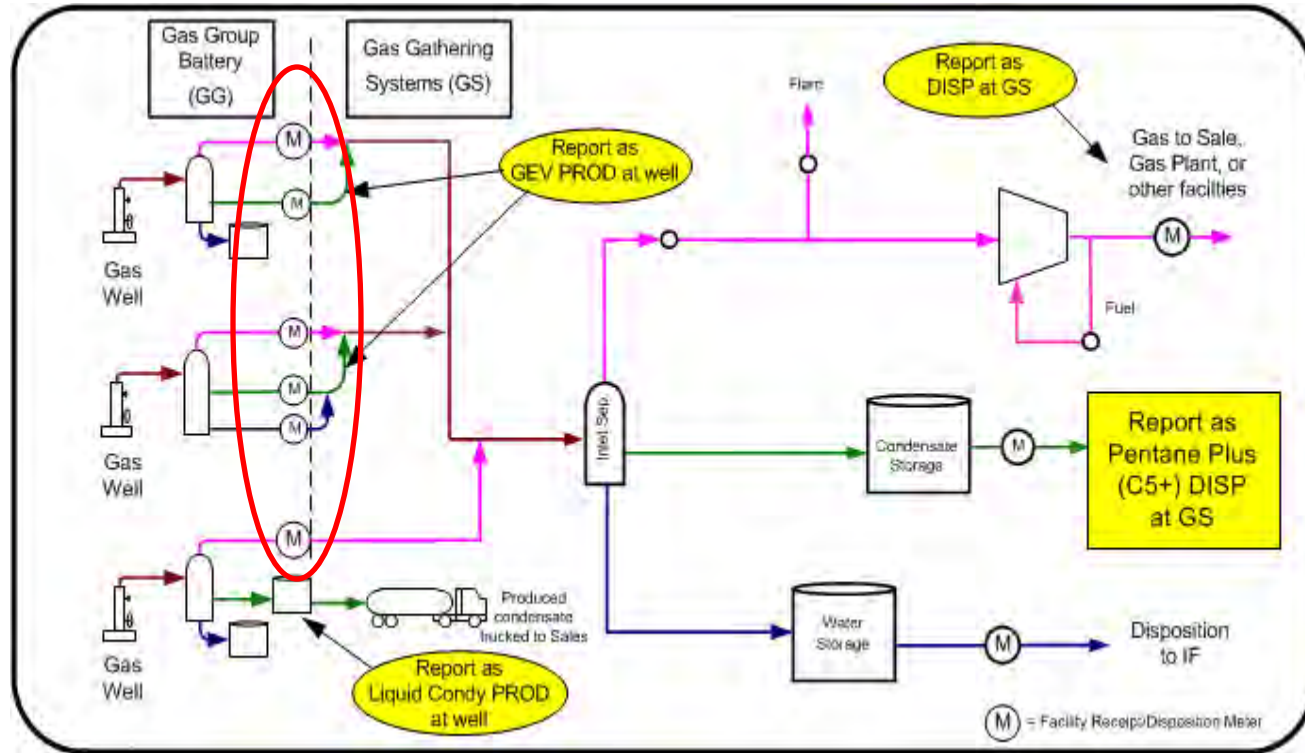

**THEME
APPLICABILITY**

- » **SINGLE-WELL OIL BATTERIES**
- Dispositions out of a single-well oil battery are determined through the “delivery-point measurement” device located at the receiving facility.

》 SUSPENDED FACILITIES

- Can report
 - facility is applicable to theme, and controls exist,
 - facility is applicable to theme, but controls do not exist, OR
 - facility is not applicable because it is suspended.

THEME APPLICABILITY

» SHUT IN FACILITIES

- For themes that would be applicable if the facility was on production **must** report either
 - facility is applicable to theme, and controls exist, OR
 - facility is applicable to theme, but controls do not exist.

**THEME
APPLICABILITY****» APPLICABLE FACILITIES –
NO CONTROLS**

- If a facility has been identified as applicable WITHOUT controls, a detailed description explaining **WHY** controls do not exist must be entered in the textbox under the column titled “Description.”

**THEME
APPLICABILITY**

- Comments must provide enough information to support the reporting

DESCRIPTION	
Inadequate Response	Adequate Response
It was found controls do not exist but will be developed during upcoming declaration period	<ul style="list-style-type: none">• We were unaware of the need for controls• Benefits deemed to not exceed costs of having controls to manage risk of noncompliance

**THEME
APPLICABILITY****» NON-APPLICABLE FACILITIES**

- A detailed explanation **WHY** the theme does not apply to a facility must be entered in the textbox under the column titled “Description.”

THEME APPLICABILITY

- Comments must provide enough information to support the reporting

DESCRIPTION	
Inadequate Response	Adequate Response
Theme does not apply to facility	<ul style="list-style-type: none"> • All 3 activities associated with the theme do not occur at the facility, OR • Fuel/Flare/Vent not occurring

DESCRIPTION	
Inadequate Response	Adequate Response
No calculation factors used at this facility	<ul style="list-style-type: none"> • The application of calculation factors is not required because (provide the reason why factors are not required to be used in the calculation of production for the wells linked to the facility)

**THEME
APPLICABILITY****» Options for Declaration Theme
Conclusion**

CONCLUSION	SELECTION CRITERIA
Acceptable	This option can be chosen if controls have been evaluated.
Deficient	This option can be chosen if controls have been evaluated.

**THEME
APPLICABILITY****» Options for Declaration Theme
Conclusion (cont'd)**

CONCLUSION	SELECTION CRITERIA
Not Applicable	<p>This option is to be chosen in the following cases:</p> <ul style="list-style-type: none">• Facilities do not exist within the applicable subtypes• All listed facilities are not applicable to the theme (e.g., EFM equipment does not exist at any facility)
Not Evaluated	<p>This option is to be chosen in the following cases:</p> <ul style="list-style-type: none">• Controls exist for the theme but were not evaluated• Controls do not exist for any of the applicable facilities

OBSERVATIONS

- 》 Feasibility of facilities being applicable to specific themes
- 》 Control evaluation—Sample size and sub-type inclusion

**USING THE
SYSTEM**

- › **Submit button**
- › **Declaration revision**
- › **Workflow status**

» EPAP on Petrinex System

- Petrinex help desk: (403)297-6111
or petrinexsupport@petrinex.ca

» AER Policy

- Contact your designated Production Audit Team member

QUESTIONS??

» **Thoughts, ideas, concerns**

Leading the next era in energy regulation

www.aer.ca



[@aer_news](https://twitter.com/aer_news)



**[www.youtube.com/user/
ABEnergyRegulator](http://www.youtube.com/user/ABEnergyRegulator)**



**[http://blog.
aer.ca](http://blog.aer.ca)**



**[www.linkedin.com/company/
alberta-energy-regulator](http://www.linkedin.com/company/alberta-energy-regulator)**